

Cable-Extension Position Transducer

Incremental Encoder Output
Ranges: 0-10 to 0-250 inches
Industrial Grade • High Cycle Applications

PT5E

Specification Summary:

GENERAL

Full Stroke Range Options 0-50 to 0-250 inches
 Output Signal Options incremental encoder (quadrature)
 Accuracy
 Typical .. the lesser of 0.02% f.s. or 0.04% of measurement \pm 1/2 pulse max.
 Best not less than 0.001 in. [0,03 mm]
 Repeatability \pm 0.02% full stroke \pm 1/2 pulse max.
 Resolution 10 to 250 pulses per inch
 Measuring Cable Options stainless steel or thermoplastic
 Enclosure Material hard anodized aluminum
 Sensor optical encoder
 Maximum Measuring Cable Velocity *see ordering information*
 Maximum Retraction Acceleration *see ordering information*
 Weight 5 lbs. max.

ELECTRICAL

Input Voltage *see ordering information*
 Input Current *see ordering information*

ENVIRONMENTAL

Enclosure NEMA 4/6, IP 65/67
 Operating Temperature 0° to 160°F (-17° to 71°C)
 Vibration up to 10 G's to 2000 Hz maximum



The PT5E encoder-based cable-extension transducer uses a unique thermoplastic cable that has virtually an infinite fatigue life. This cable, known as V62, has properties that are superior for high cycle and rugged applications.

Like Celesco's other transducers, the PT5E installs in minutes, functions properly without perfectly parallel alignment, and fits easily into small areas. The PT5E offers additional installation flexibility since its cable exit can be rotated relative to the mounting surface, providing four different cable exit orientations.

Outline Drawing

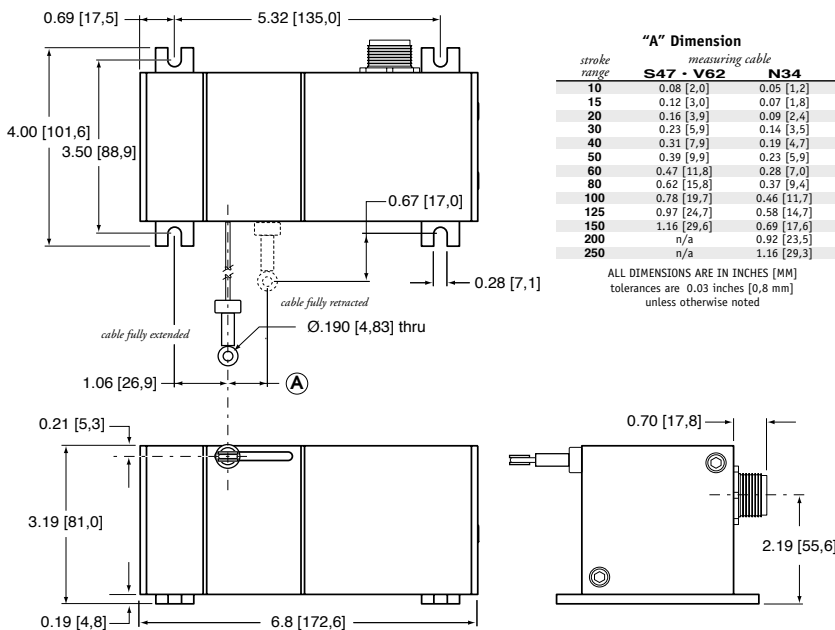

Output Signal

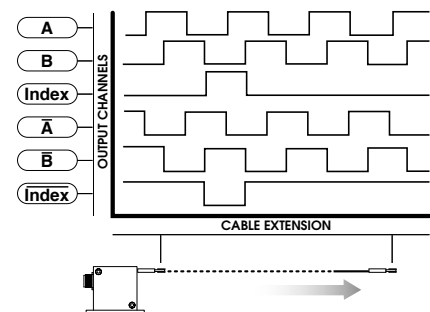

Ordering Information:

Model Number:

PT5E - _____
order code: **R** **A** **B** **C** **D** **E**

Sample Model Number:

PT5E - 100 - N34 - FR - 100 - AB-TTL - M6

- R** range: 100 inches
- A** measuring cable: .034 nylon-coated stainless steel
- B** cable exit: front
- C** resolution: 100±2 pulses per inch
- D** output signal: TTL/CMOS compatible driver
- E** electrical connection: 6-pin plastic connector

Full Stroke Range:

R <i>order code:</i>	50	100	150	200	250	1250	2500	3750	5000	6250
full stroke range, min:	50 in.	100 in.	150 in.	200 in.	250 in.	1250 mm	2500 mm	3750 mm	5000 mm	6250 mm
cable tension (20%):	41 ounces			21 ounces			11,4 N			5,8 N
max. cable velocity • acceleration:	300 in./sec • 5 G's			120 in./sec • 2 G's			8 M/sec • 5 G's			3 M/sec • 2 G's

Measuring Cable:

A <i>order code:</i>	N34	S47	V62
	.034 nylon-coated stainless steel <i>available in all ranges</i>	.047 stainless steel <i>all ranges up to 150 inches</i>	.062 thermoplastic <i>all ranges up to 150 inches</i>

Cable Exit:

B <i>order code:</i>	UP	DN	FR	BK
direction:	up	down	front	back
	inches [mm]			

Resolution:

C <i>order code:</i>	10	100	200	250
resolution for english ranges:	10 ±0.2 pulses per inch	100 ±2 pulses per inch	200 ±4 pulses per inch	250 ±5 pulses per inch
C <i>order code:</i>	.5	5	10	12.5
resolution for metric ranges:	0.5 ±0.01 pulses per mm	5 ±0.1 pulses per mm	10 ±0.2 pulses per mm	12.5 ±0.3 pulses per mm

Ordering Information (cont.)

Output Signals:

① order code:	AB-TTL	AB-OC	ABC-LD	ABC-UD	ABCZ-UD
output driver:	TTL/CMOS compatible	open collector	5-volt line driver	universal line driver <i>(no index)</i>	universal line driver <i>(with index)</i>
input voltage:	4.5...13.2 VDC	10.8...26.4 VDC	5 VDC	5...30 VDC	5...30 VDC
max. source/sink current:	20 mA sink	20 mA sink	20 mA sink	20 mA source/sink	20 mA source/sink
max. input current:	80 mA	80 mA	150 mA	100 mA, no load	100 mA, no load

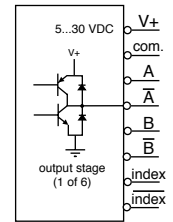
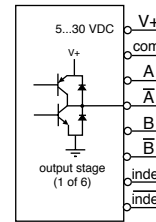
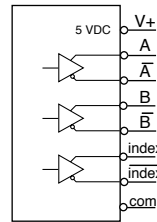
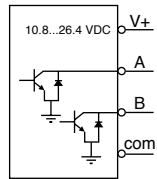
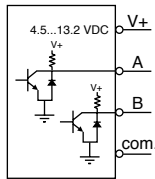

Electrical Connection:

③ order code:	MC4	M6	M6M	M18	C25
	4-pin micro-connector with 12 ft [3.5 M] cord set	6-pin plastic connector with mating plug	6-pin metal connector with mating plug	18-pin plastic connector with mating plug	25-ft. instrumentation cable 24 AWG, shielded
	IP 67, NEMA 6	IP 67, NEMA 6	IP 65, NEMA 4	IP 67, NEMA 6	IP 67, NEMA 6
	1.2 in. [31 mm]	3.0 in. [78 mm]	2.4 in. [60 mm]	2.5 in. [64 mm]	
	12 ft. x 5/16-in. dia. [3,5 M x 8 mm dia.] yellow PVC jacket 22AWG, shielded	.30 - .39 in. [8 - 10 mm] cable dia. 16 AWG max conductor size connector: MS3102E-14S-6P mating plug: MS3106E-14S-6S	.375 in. [9 mm] max cable dia. 16 AWG max conductor size connector: MS3102E-14S-6P mating plug: MS3106E-14S-6S	.26 - .30 in. [7 - 8 mm] cable dia. 20 - 24 AWG conductor size connector: Conxall 14282-18PG-300-K mating plug: Conxall 13282-18SG-326-K	25 ft. x 0.2-in. dia. [7,5 M x 5 mm dia.] 24 AWG, shielded

4-pin cordset:



pin	color code	All Drivers
1	RED-BLK TR.	input voltage
2	RED-WHT TR.	channel A
3	RED	channel B
4	GREEN	common

6-pin mating plug:

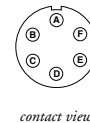

pin	TTL/CMOS Open Collector	5 V Line Driver Universal Line Driver
A	input voltage	input voltage
B	common	common
C	channel A	channel A
D	channel B	channel B
E	-	channel A'
F	-	channel B'

18-pin mating plug:

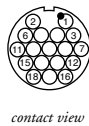

pin	TTL/CMOS Open Collector	5 V Line Driver Universal Line Driver
1	input voltage	input voltage
2	common	common
3	channel B	channel B
6	channel A	channel A
7	-	index
11	-	channel B'
12	-	channel A'
15	-	index'

25-ft. instrumentation cable:

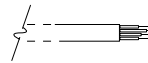

color	TTL/CMOS Open Collector	5 V Line Driver Universal Line Driver
red	input voltage	input voltage
black	common	common
green	channel A	channel A
white	channel B	channel B
blue	-	channel A'
brown	-	channel B'
yellow	-	index
orange	-	index'