

Inclinometer

4...20 mA Output • Hazardous Area Certification

Ranges: 0-45° to 0-240°

Industrial Grade



IT9420

Specification Summary:

GENERAL

Available Full Stroke Ranges.....0-45 to 0-240 degrees
 Weight (aluminum enclosure)..... 5 lb. typical (aluminum enclosure)
 Enclosure Material aluminum (stainless steel available)
 Sensor precision potentiometer
 Electrical Connector.....MS3102E-14S-6P
 Mating Plug (included)MS3106E-14S-6S

ELECTRICAL

Output Signal 4...20 mA
 Input Voltage.....*see ordering information*
 Input Current 20 mA max.
 Circuit Protection 38 mA maximum

PERFORMANCE

Sensitivity..... 16 mA/full stroke, $\pm 0.25\%$
 Accuracy* $\pm 1\%$ full stroke
 Accuracy Option..... 0.5% full stroke—*please contact factory*
 Resolution..... essentially infinite
 Output Signal Adjustment for Full Stroke Ranges of 45° - 105°:
 Zero Adjustmentfrom factory set zero to 20% of full stroke range
 Span Adjustment to 20% of factory set span
 Output Signal Adjustment for Full Stroke Ranges of 120° - 240°:
 Zero Adjustmentfrom factory set zero to 40% of full stroke range
 Span Adjustment to 40% of factory set span
 *—when plane of pendulum motion parallel to plane of rotation within $\pm 3^\circ$

ENVIRONMENTAL

EnclosureNEMA 4/4X/6, IP 67/68
 Hazardous Area Certification*see ordering information*
 Operating Temperature..... -30° to 200°F (-34° to 90°C)
 Vibration..... up to 10 G's to 2000 Hz maximum



The model IT9420 is a rugged yet simple device which provides a 4 to 20 mA current feedback signal for incline position. The heart of the IT9420 is a magnetically-damped pendulum coupled to a conductive plastic precision potentiometer. A highly linear relationship between inclination and a 4 to 20 mA output is maintained over the full range of the IT9420.

The IT9420 is easy to use: simply attach it to the object of measurement and install two wires for the current loop.

Outline Drawing

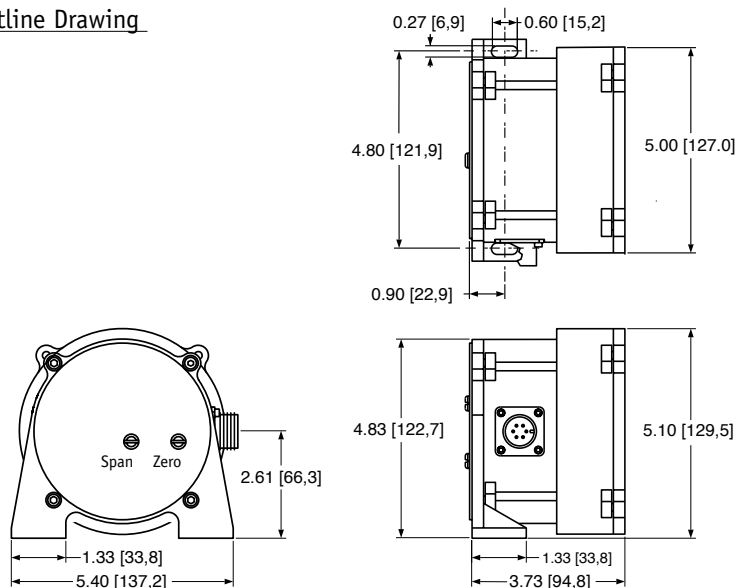

DIMENSIONS ARE IN INCHES [MM] tolerances are ± 0.02 in. [± 0.5 mm] unless otherwise specified

Output Signal

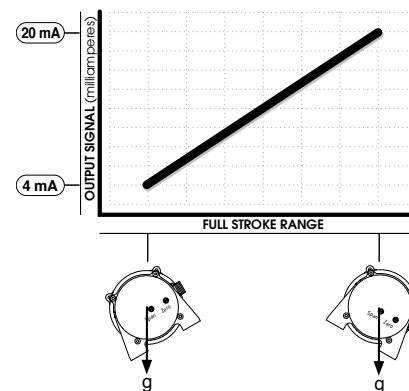

Ordering Information:

Model Number:

IT9420 - _____ - _____ - _____ - _____ - _____
 order code: CW CCW A B C D

Sample Model Number:
IT9420 - 060 - 120 - 1110

- CW** clockwise rotation: 60°
- CCW** counter-clockwise rotation: 120° } total rotation = 180°
- A** enclosure: aluminum
- B** output signal: 4 mA @ 120° CCW
20 mA @ 60° CW
- C** electrical connection: 6-pin plastic connector
- D** magnetic dampening: yes

Full Clockwise Rotation:

CW order code:	000	015	030	045	060	075	090	105	120
	0°	15°	30°	45°	60°	75°	90°	105°	120°

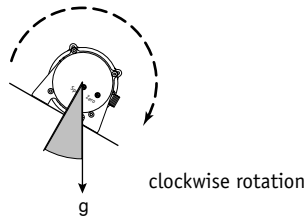

*Important--
 the sum of the Clockwise and Counter-Clockwise Rotations must be in the range of 45° to 240°*

Full Counter-Clockwise Rotation:

CCW order code:	000	015	030	045	060	075	090	105	120
	0°	15°	30°	45°	60°	75°	90°	105°	120°

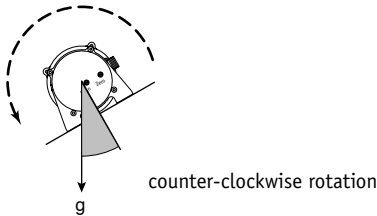

*Important--
 the sum of the Clockwise and Counter-Clockwise Rotations must be in the range of 45° to 240°*

Enclosure Material:

A order code:	1	2
	powder-painted aluminum	303 stainless steel

Output Signal:

B order code:	1	2	5	6
output signal options:	4...20 mA	20...4 mA	4...20 mA	20...4 mA
input voltage:	8 - 40 vdc		14 - 32 vdc	

hazardous area certification: not certified

CSA Standard 22.2
 Class 1
 Groups A, B, C and D

Cenelec
 LCIE EEx
 ia IIC T4

**IMPORTANT: intrinsically safe when powered from a CSA certified zener barrier rated 28 VDC max, 110 mA max per installation drawing#677984*

Ordering Information:

Electrical Connection:

1 **order code:** 6-pin plastic connector w/mating plug
IP 67, NEMA 4X** , 6

3.0 in. [78 mm]
1/2 - 5/16" [14 - 8 mm] cable dia.
16 AWG max conductor size
connector: MS3102E-14S-6P
mating plug: MS3106E-14S-6S

2 **order code:** 10-ft. [3 M] waterproof cable
IP 67, NEMA 4X** , 6

10 ft. x 0.4-in. dia. [3 M x 10 mm dia.]
18 AWG, type SJTW

4 **order code:** 25-ft. [7.5 M] instrumentation cable
IP 67, NEMA 6

25 ft. x 0.2-in. dia. [7,5 M x 5 mm dia.]
24 AWG, shielded

5 **order code:** 100-ft. [30 M] waterproof cable
IP 67, NEMA 4X** , 6

100 ft. x 0.4-in. dia. [30 M x 10 mm dia.]
18 AWG, type SJTW

6 **order code:** 10-ft. [3 M] pressure tested* waterproof cable
IP 68, NEMA 4X** , 6P

10 ft. x 0.4-in. dia. [3 M x 10 mm dia.]
18 AWG, type SJTW

7 **order code:** 100-ft. [30 M] pressure tested* waterproof cable
IP 68, NEMA 4X** , 6P

100 ft. x 0.4-in. dia. [30 M x 10 mm dia.]
18 AWG, type SJTW

6-pin Mating Plug		Waterproof Cable		Instrumentation Cable	
pin	signal	color code	signal	color code	2-wire
A	8...40 vdc	WHITE	8...40 vdc	RED	8...40 vdc
B	4...20 mA out	BLACK	4...20 mA out	BLACK	4...20 mA out
C	-	GREEN	case ground	WHITE	n/a
D	case ground			GREEN	case ground

contact view

*-Test pressure: 100 feet [30 meters] H₂O (40 PSID) Test Medium: Air; Duration: 2 hours. **-applies to stainless steel enclosure only.

Dampening Option:

0 **order code:** with magnetic dampening

1 **order code:** without magnetic dampening

Output Signal Selection:

The output signal direction can be reversed at any time by simply changing the dip-switch settings found on the internal signal board. After the settings have been changed, adjustment of the Zero and Span trimpots will be required to precisely match the 4 mA and 20mA signal values to the beginning and end points of the stroke.

To gain access to the signal board, remove four Allen-Head Screws and remove end cover bracket.

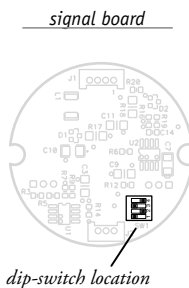
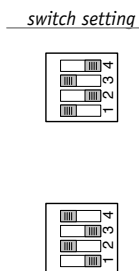
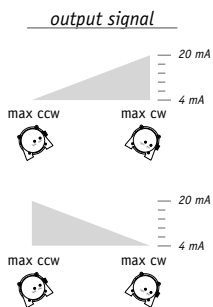

internal dip switches & signal board

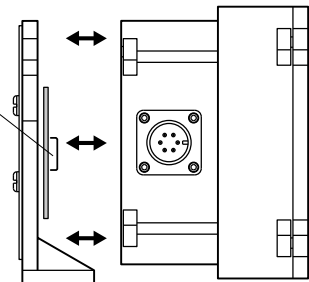

version: 3.0 last updated: October 17, 2007